

Chrome DIN Rail Power Supply

24V 60W 1 Phase (Class II & NEC Class 2) / DRC-24V60W1AZ



CHROME

Highlights & Features

- Protection Class II, Double Isolation (No Earth connection is required)
- Universal AC input voltage and full power up to 55°C
- Power will not de-rate for the entire input voltage range
- Efficiency > 88.0% @ 115Vac & 230Vac
- NEC Class 2 / Limited Power Source (LPS) certified
- Overvoltage / Overcurrent / Over Temperature Protections

Safety Standards



CB Certified for worldwide use

Model Number: DRC-24V60W1AZ
Unit Weight: 0.22 kg
Dimensions (L x W x D): 91 x 71 x 55.6 mm

General Description

The DRC-24V60W1AZ is part of the Chrome DIN Rail Power Supply series, which is designed for use in compact cabinets for home automations and the food and beverage industry. Delta's Chrome DIN Rail Power Supply series offers double isolated input. This means that no Earth connection is required thus resulting in low leakage current. This product provides a universal input voltage range of 90-264Vac, and a wide temperature range of -25°C to 71°C. The Chrome series is certified to safety standard according to IEC/EN/UL 60950-1 Information Technology Equipment (ITE) and UL 508 Industrial Control Equipment (ICE). The series is also fully compliant with RoHS Directive 2011/65/EU for environmental protection. NEC Class 2 and Limited Power Source (LPS) approvals are available for this product.

Model Information

Chrome DIN Rail Power Supply

Model Number	Input Voltage Range	Output Voltage	Output Current
DRC-24V60W1AZ	90-264Vac (125-375Vdc)	24Vdc	2.50A

Model Numbering

DR	C -	24V	60W	1	A	Z
DIN Rail	Isolation Class II Power Supply	Output Voltage	Output Power	Single Phase	Chrome Series	Plastic Case

Chrome DIN Rail Power Supply

24V 60W 1 Phase (Class II & NEC Class 2) / DRC-24V60W1AZ

Specifications

Input Ratings / Characteristics

Nominal Input Voltage	100-240Vac
Input Voltage Range	90-264Vac
Nominal Input Frequency	50-60Hz
Input Frequency Range	47-63Hz
Nominal DC Input Voltage*	125-375Vdc
Input Current	< 1.50A @ 115Vac, < 1.00A @ 230Vac
Efficiency at 100% Load	> 88.0% @ 115Vac & 230Vac
Max Inrush Current (Cold Start)	< 30A @ 115Vac, < 60A @ 230Vac
Power Factor	Conform to EN 61000-3-2
Leakage Current	< 0.25mA @ 240Vac

*Fulfills the test conditions for this range.

Output Ratings / Characteristics

Nominal Output Voltage	24Vdc
Output Voltage Tolerance	± 2% (initial set point tolerance from factory)
Output Voltage Adjustment Range	24-28Vdc
Output Current	2.50A
Output Power	60W
Line Regulation	< 1% typ. (@ 90-264Vac, 100% load)
Load Regulation	< 2% typ. (@ 90-264Vac, 100% load)
PARD (20MHz)	150mVpp
Rise Time	< 100ms @ nominal input (100% load)
Start-up Time	< 3,000ms @ nominal input (100% load)
Hold-up Time	> 16ms @ 115Vac, > 30ms @ 230Vac (100% load)
Dynamic Response (Overshoot & Undershoot O/P Voltage)	± 5% @ 10-100% load
Start-up with Capacitive Loads	3,000µF Max

Mechanical

Case Cover	Plastic
Dimensions (L x W x D)	91 x 71 x 55.6 mm
Unit Weight	0.24 kg
Indicator	Green LED (DC OK)
Cooling System	Convection
Terminal	Input Output
	2 Pins (Rated 300V/25A) 4 Pins (Rated 300V/25A)
Wire	Input / Output
	AWG 22-12
Mounting Rail	Standard TS35 DIN Rail in accordance with EN 60715
Noise (1 Meter from power supply)	Sound Pressure Level (SPL) < 25dBA

Chrome DIN Rail Power Supply

24V 60W 1 Phase (Class II & NEC Class 2) / DRC-24V60W1AZ

Environment

Surrounding Air Temperature	Operating	-25°C to +71°C
	Storage	-25°C to +85°C
Power De-rating	> 55°C de-rate power by 2.5% / °C	
Operating Humidity	5 to 95% RH (Non-Condensing)	
Operating Altitude	0 to 2,000 Meters	
Shock Test (Operating)	IEC 60068-2-27, Half Sine Wave: 4G for a duration of 22ms, 3 shocks for each 3 directions, 9 times in total	
Vibration (Operating)	IEC 60068-2-6, Sine Wave: 10-500Hz @ 19.6m/S ² (2G peak); 10 min per cycle, 60 min for all X, Y, Z directions	
Pollution Degree	2	

Protections

Overvoltage	< 34.8V, SELV Output, Latch-off Mode
Overload / Overcurrent	> 110% of rated load current, Hiccup Mode, Non-Latching (Auto-Recovery when the fault is removed)
Over Temperature	< 75°C Surrounding Air Temperature @ 100% load, Latch-off Mode
Short Circuit	Hiccup Mode, Non-Latching (Auto-Recovery when the fault is removed)
Degree of Protection	IP20
Protection Against Shock	Class II (No PE* connection is required)

*PE: Primary Earth

Reliability Data

MTBF	> 500,000 hrs. as per Telcordia SR-332 I/P: 100Vac, O/P: 100% load, Ta: 35°C
Expected Cap Life Time	10 years (115Vac & 230Vac, 50% load @ 40°C)

Chrome DIN Rail Power Supply

24V 60W 1 Phase (Class II & NEC Class 2) / DRC-24V60W1AZ

Safety Standards / Directives

Electrical Safety	TUV to EN 60950-1, UL/cUL recognized to UL 60950-1 and CSA C22.2 No. 60950-1, CB scheme to IEC 60950-1, Limited Power Source (LPS)	
Industrial Control Equipment	UL/cUL listed to UL 508 and CSA C22.2 No. 107.1-01	
Class 2 Power Supply	UL/cUL recognized to UL 60950-1 and CSA C22.2 No. 60950-1	
CE	In conformance with EMC Directive 2004/108/EC and Low Voltage Directive 2006/95/EC	
Material and Parts	RoHS Directive 2011/65/EU Compliant	
Galvanic Isolation	Input to Output	3.0KVac

EMC

EMC / Emissions	CISPR 22, EN 55022, FCC Title 47: Class A*	
Immunity to	EN 55024	
Electrostatic Discharge	IEC 61000-4-2	Level 3 Criteria A ¹⁾ Air Discharge: 8kV Contact Discharge: 4kV
Radiated Field	IEC 61000-4-3	Level 2 Criteria A ¹⁾ 80MHz-1GHz, 3V/M with 1kHz tone / 80% modulation
Electrical Fast Transient / Burst	IEC 61000-4-4	Level 3 Criteria A ¹⁾ 2kV
Surge	IEC 61000-4-5	Level 3 Criteria A ¹⁾ Common Mode ²⁾ : 2kV Differential Mode ³⁾ : 1kV
Conducted	IEC 61000-4-6	Level 2 Criteria A ¹⁾ 150kHz-80MHz, 3Vrms
Power Frequency Magnetic Fields	IEC 61000-4-8	Criteria A ¹⁾ 1A/Meter
Voltage Dips	IEC 61000-4-11	> 95% dip; 0.5 cycle (10ms); Self Recoverable
Low Energy Pulse Test (Ring Wave)	IEC 61000-4-12	Level 3 Criteria A ¹⁾ Common Mode ²⁾ : 2kV Differential Mode ³⁾ : 1kV
Voltage Fluctuation and Flicker	IEC/EN 61000-3-3	

1) Criteria A: Normal performance within the specification limits

2) Asymmetrical: Common mode (Line to earth)

3) Symmetrical: Differential mode (Line to line)

*Warning: This is a Class A product. In a residential, commercial or light industrial environment it may cause radio interference. This product is not intended to be installed in a residential environment; in a commercial and light industrial environment with connection to the public mains supply, the user may be required to take adequate measures to reduce interference.

Chrome DIN Rail Power Supply

24V 60W 1 Phase (Class II & NEC Class 2) / DRC-24V60W1AZ

Block Diagram

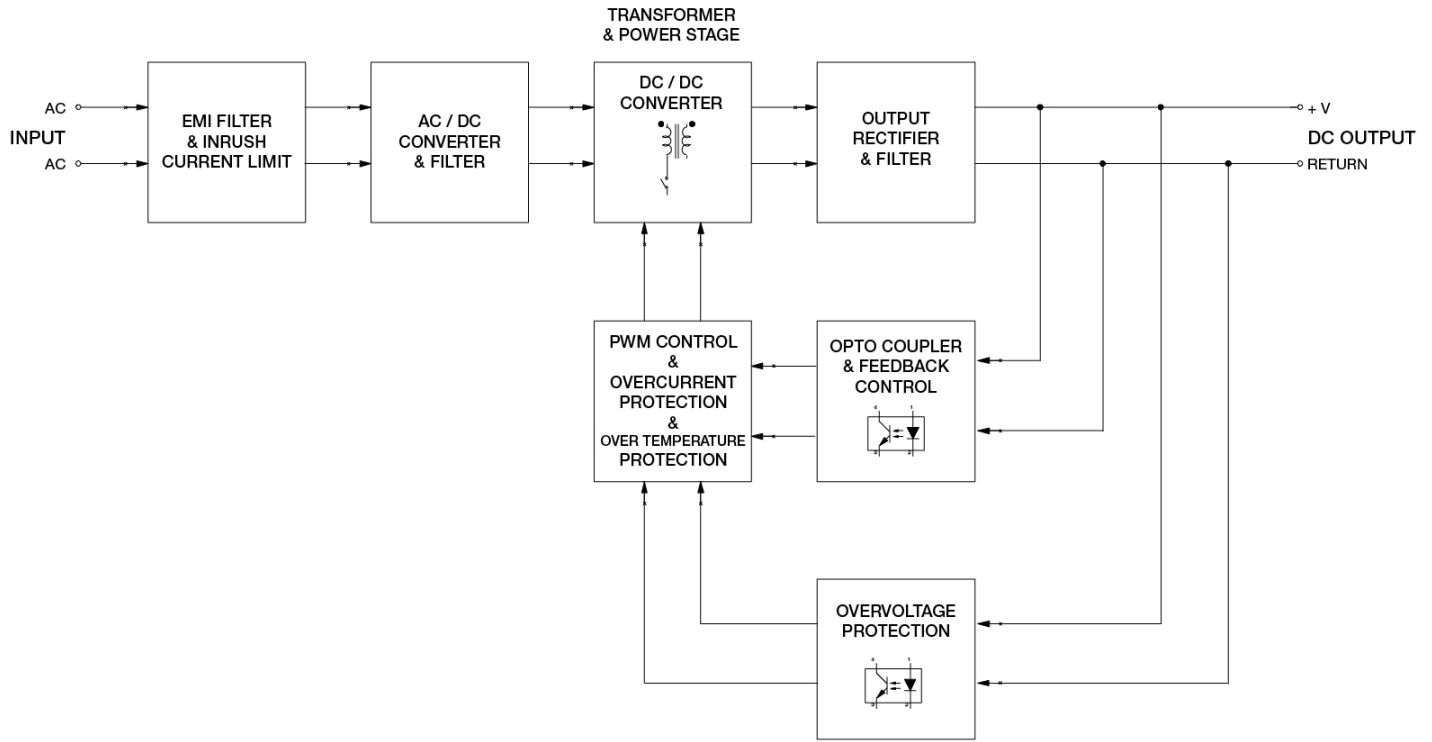

Device Description

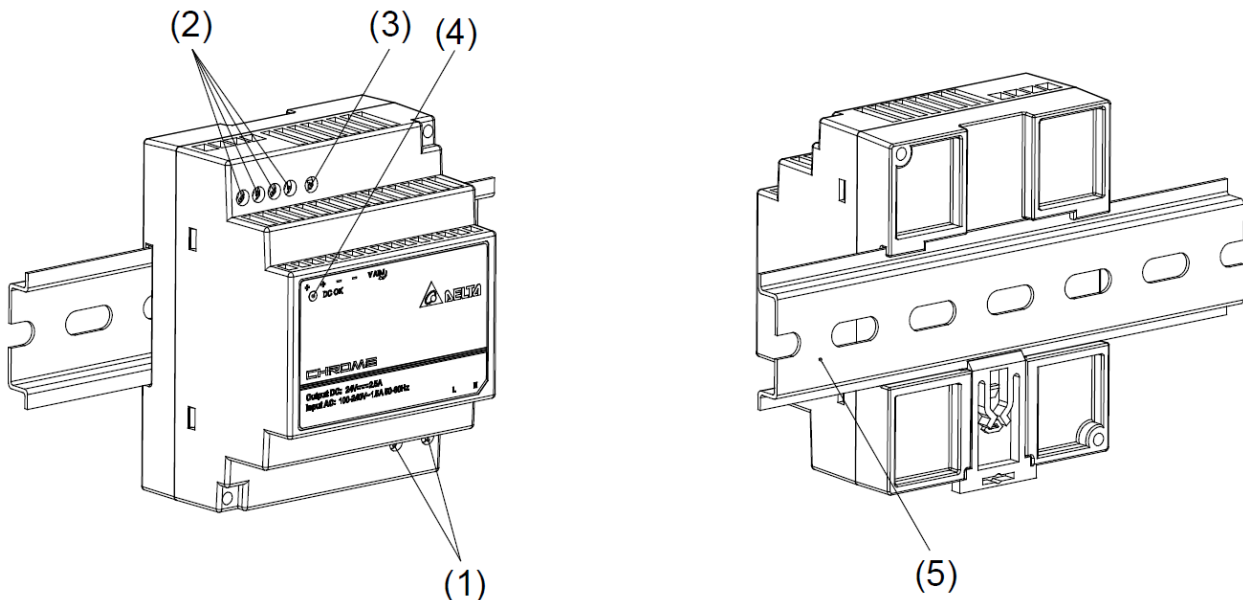

- 1) Input terminal block connector
- 2) Output terminal block connector
- 3) DC voltage adjustment potentiometer
- 4) DC OK control LED (Green)
- 5) Universal mounting system

Chrome DIN Rail Power Supply

24V 60W 1 Phase (Class II & NEC Class 2) / DRC-24V60W1AZ

Dimensions

L x W x D: 91 x 71 x 55.6 mm

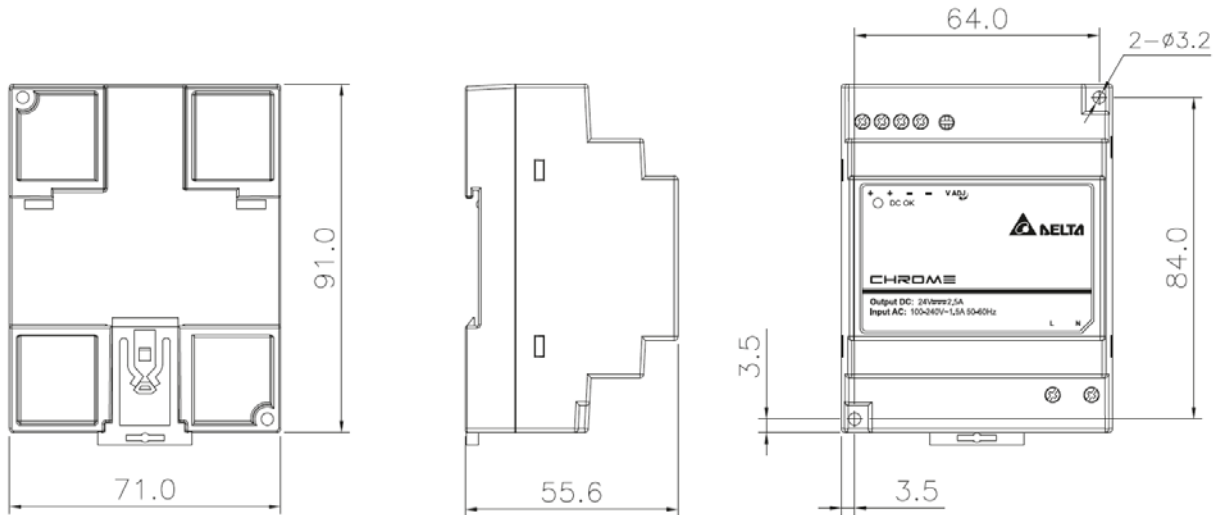

Engineering Data

De-rating

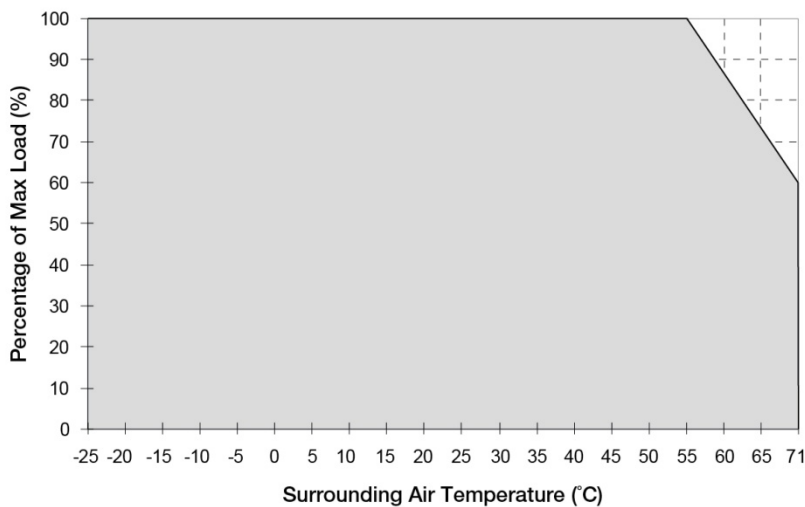

Fig. 1 De-rating for Vertical Mounting Orientation
 > 55°C de-rate power by 2.5% / °C

Note

1. Power supply components may degrade, or be damaged, when the power supply is continuously used outside the shaded region, refer to the graph shown in Fig. 1.
2. If the output capacity is not reduced when the surrounding air temperature >55°C, the device may run into Over Temperature Protection. When activated, the output voltage will go into latch-off mode and recoverable by AC power recycle.
3. In order for the device to function in the manner intended, it is also necessary to keep a safety distance of 25mm with adjacent units while the device is in operation.
4. Depending on the surrounding air temperature and output load delivered by the power supply, the device can be very hot!
5. If the device has to be mounted in any other orientation, please do not hesitate to contact info@deltapsu.com for more details.

Chrome DIN Rail Power Supply

24V 60W 1 Phase (Class II & NEC Class 2) / DRC-24V60W1AZ

Output De-rating VS. Input Voltage

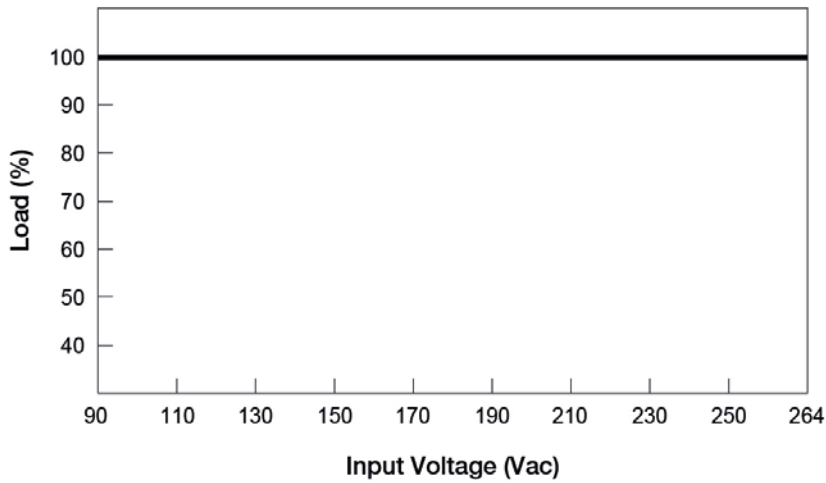

■ No output power de-rating across the entire input voltage range

Assembly & Installation

The power supply unit (PSU) can be mounted on 35mm DIN rails in accordance with EN 60715. The device should be installed with input terminal block at the bottom.

Each device is delivered ready to install.

Mounting

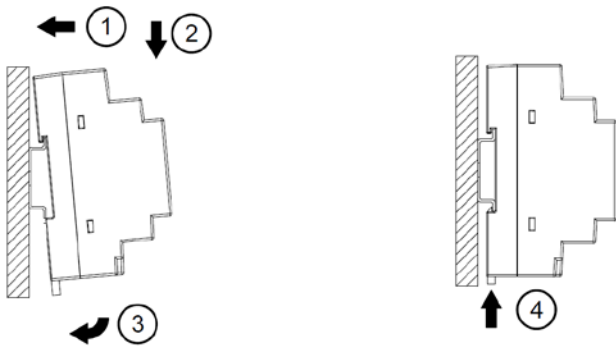

Fig. 2.1 Mounting

Snap on the DIN rail as shown in Fig. 2.1:

1. Tilt the unit upwards and insert it onto the DIN rail.
2. Push downwards until stopped.
3. Press against the bottom front side for locking.
4. Shake the unit slightly to ensure that it is secured.

Dismounting

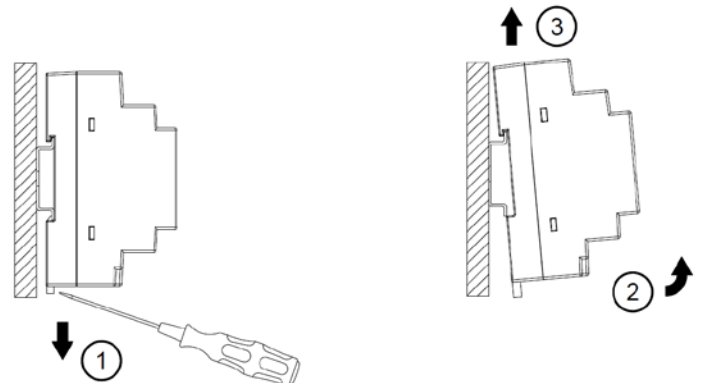

Fig. 2.2 Dismounting

To uninstall, pull or slide down the latch with screw driver as shown in Fig. 2.2. Then slide the power supply unit (PSU) in the opposite direction, release the latch and pull out the power supply unit (PSU) from the rail.

Chrome DIN Rail Power Supply

24V 60W 1 Phase (Class II & NEC Class 2) / DRC-24V60W1AZ

Safety Instructions

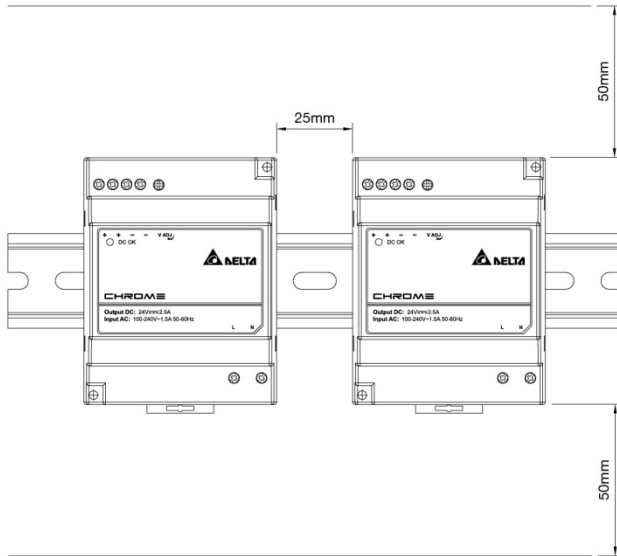

- ALWAYS switch mains of input power OFF before connecting and disconnecting the input voltage to the unit. If mains are not turned OFF, there is risk of explosion / severe damage.
- **To guarantee sufficient convection cooling, keep a distance of 50mm above and below the device as well as a lateral distance of 25mm to other units.**
- Note that the enclosure of the device can become very hot depending on the surrounding air temperature and load of the power supply. Risk of burns!
- DO NOT insert any objects into the unit.
- Hazardous voltages may be present for up to 5 minutes after the input mains voltage is disconnected. Do not touch the unit during this time.
- The power supplies unit should be installed in minimum IP54 rated enclosure.
- The power supplies are built in units and must be installed in a cabinet or room (condensation free environment and indoor location) that is relatively free of conductive contaminants.

Functions

■ Graph illustrating the Start-up Time, Rise Time, and Hold-up Time

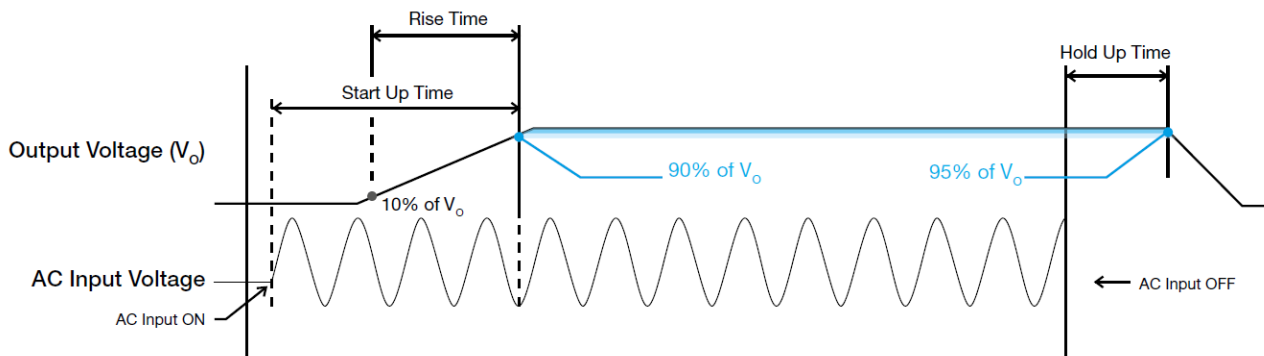

Start-up Time

The time required for the output voltage to reach 90% of its set value, after the input voltage is applied.

Rise Time

The time required for the output voltage to change from 10% to 90% of its set value.

Hold-up Time

Hold up time is the time when the AC input collapses and output voltage retains regulation for a certain period of time. The time required for the output to reach 90% of its set value, after the input voltage is removed.

Chrome DIN Rail Power Supply

24V 60W 1 Phase (Class II & NEC Class 2) / DRC-24V60W1AZ

Inrush Current

Inrush current is the peak, instantaneous, input current measured and, occurs when the input voltage is first applied. For AC input voltages, the maximum peak value of inrush current will occur during the first half cycle of the applied AC voltage. This peak value decreases exponentially during subsequent cycles of AC voltage.

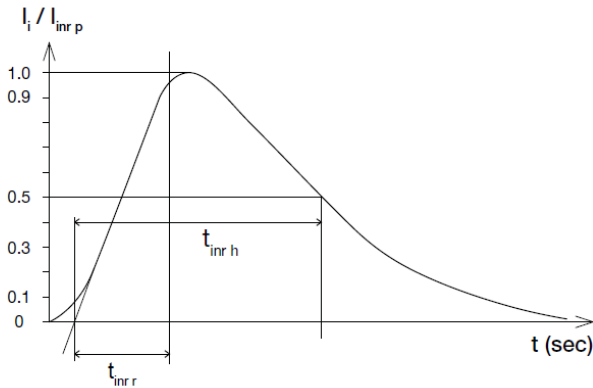

Dynamic Response

The power supply output voltage will remain within $\pm 5\%$ of its steady state value, when subjected to a dynamic load from 10 to 100% of its rated current.

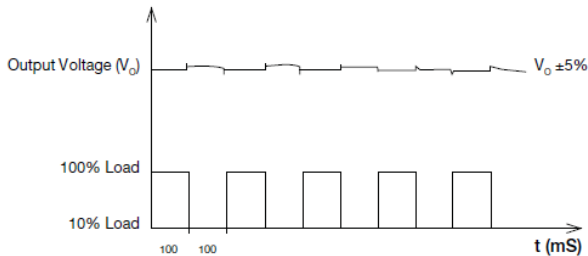

Overvoltage Protection

The power supply's overvoltage circuit will be activated when its internal feedback circuit fails. The output voltage shall not exceed its specifications defined on Page 3 under "Protections".

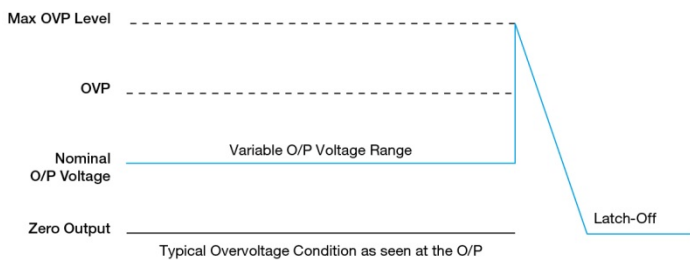

Overload & Overcurrent Protections

The power supply's Overload (OLP) and Over current (OCP) Protections will be activated when output current exceeds 110% of I_o (Max load). In such occurrence, once the power supply has reached its maximum power limit, the protection is activated and the power supply will go into "Hiccup mode" (Auto-Recovery). The power supply will recover once the fault condition of the OLP and OCP is removed and I_o is back within the specifications.

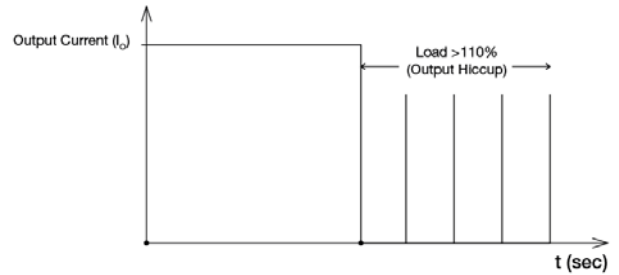

Over Temperature Protection

As mentioned above, the power supply also has Over Temperature Protection (OTP). In the event of a higher operating temperature at 100% load, the power supply will run into OTP when the operating temperature is beyond what is recommended in the de-rating graph. When activated, the output voltage will go into latch-off mode until the component temperature cools down and the AC power is recycled.

Short Circuit Protection

The power supply's output OLP/OCP function also provides protection against short circuits. When a short circuit is applied, the output current will operate in "Hiccup mode", as shown in the illustration in the OLP/OCP section on this page. The power supply will return to normal operation after the short circuit is removed.

Chrome DIN Rail Power Supply

24V 60W 1 Phase (Class II & NEC Class 2) / DRC-24V60W1AZ

Operating Mode

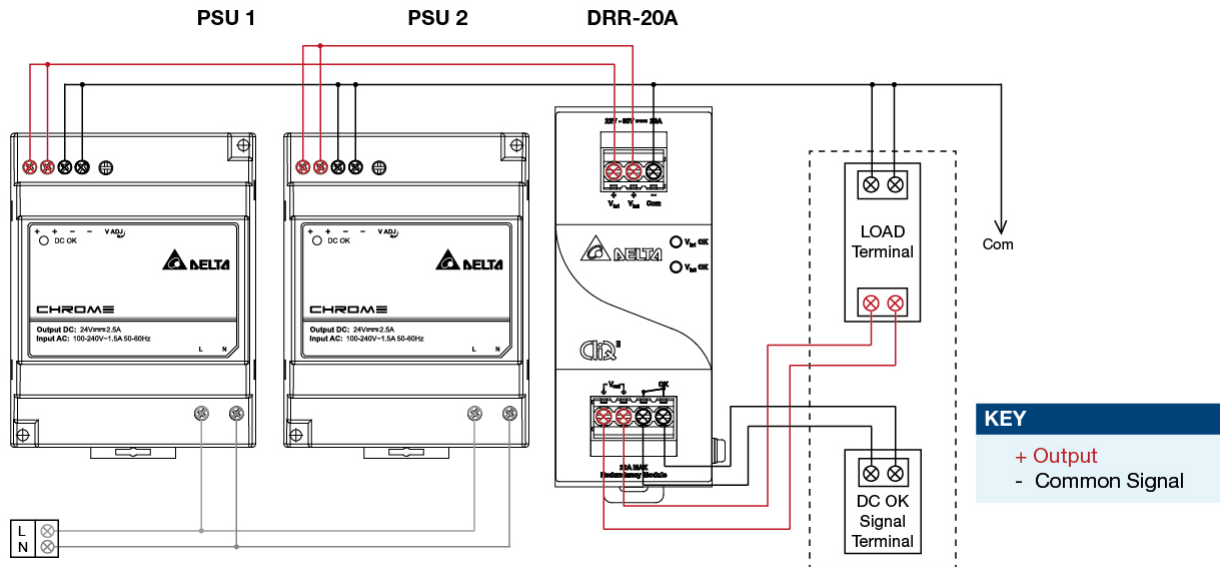

Fig. 3 Redundancy / Parallel Operation Connection Diagram

■ Redundancy Operation

In order to ensure proper redundancy operation for the power supply unit (PSU), ensure that the output voltage difference between the two units is kept at 0.45–0.50V for 24V supplies. Follow simple steps given below to verify:

- Step 1.**
Measure output voltage of PSU 1 and PSU 2. If PSU 1 is the master unit, then V_O of PSU 1 must be higher than PSU 2. In order to set the output voltage, connect the power supply to 50% load and set the PSU 1 and PSU 2 output voltage.
- Step 2.**
Connect the right DRR module, 20A as per the system requirement to the power supply units PSU 1 and PSU 2 at $V_{in 1}$ & $V_{in 2}$ respectively.
- Step 3.**
Connect the system load from V_{out} . Please note that output voltage V_{out} from DRR module will be = V_O (output voltage of power supply) – V_{drop}^* (in DRR module).

■ Parallel Operation

These DRR modules can also be used for Parallel function in order to increase the output power by N+1 (e.g. 2.5A + 2.5A = 5A or 2.5A + 2.5A + 2.5A = 7.5A) or current sharing, and thus increasing the power supply and system reliability. Though the DRC-24V60W1AZ is not designed for current sharing, a good current sharing between two power supplies can be achieved by following simple steps as below (Refer to Fig. 3 for the Connection Diagram).

- Step 1.**
Set output load condition for both supplies at 50% and measure the output voltages.
- Step 2.**
Adjust output voltages to the same level or within $\pm 25mV$ difference.
- Step 3.**
Connect PSU 1 and PSU 2 with the DRR-20A module and measure at $V_{in 1}$ & $V_{in 2}$ to verify the voltage difference. Ensure the voltages are within $\pm 25mV$.
- Step 4.**
Output voltage from DRR module V_{out} will be = V_O (output voltage of power supply) – V_{drop}^* (in DRR module).

* V_{drop} will vary from 0.60V to 0.90V (Typical 0.65V) depending on the load current and surrounding air temperature.

Chrome DIN Rail Power Supply

24V 60W 1 Phase (Class II & NEC Class 2) / DRC-24V60W1AZ

Others

Delta RoHS Compliant



Restriction of the usage of hazardous substances

The European directive 2011/65/EU limits the maximum impurity level of homogeneous materials such as lead, mercury, cadmium, chrome, polybrominated flame retardants PBB and PBDE for the use in electrical and electronic equipment. RoHS is the abbreviation for "Restriction of the use of certain hazardous substances in electrical and electronic equipment".

This product conforms to this standard.